



"The sneeze guard with curve appeal"

STANDARD SPECIFICATIONS:

ITEM: _____
 QTY: _____
 MODEL: **M-105**
 LENGTH: _____

Posts

- 1" Diameter stainless steel post
- 2" Diameter stainless steel flange
- Stainless steel glass clips
- Brushed #4 stainless steel finish

Unit

- NSF Certified
- Mounting hardware provided
- Clear tempered glass with polished edges
 - 1/4" glass (max. span 40")
 - 3/8" Glass (max. span 60")

OPTIONS AND ACCESSORIES:

Tube Size

- 1 1/2" Diameter
- 2" Diameter
- 1 1/2" Square
- 2" Square
- Other _____

Metal Finish

- Mirror Polished #8
- Powder Coat Color
RAL# _____
- Other _____

Glass Options

- Frosted
- Frosted logo
- Acrylic

Accessories

- Channel in lieu of glass clips
- Glass end panels
- Heat strips
- Heat strips with lights
- Fluorescent lights
- LED lights
- Cross supports

Mounting Options

- Round flange
- Narrow flange
- Undercounter mount
- Wall mount
- Heavy duty mount

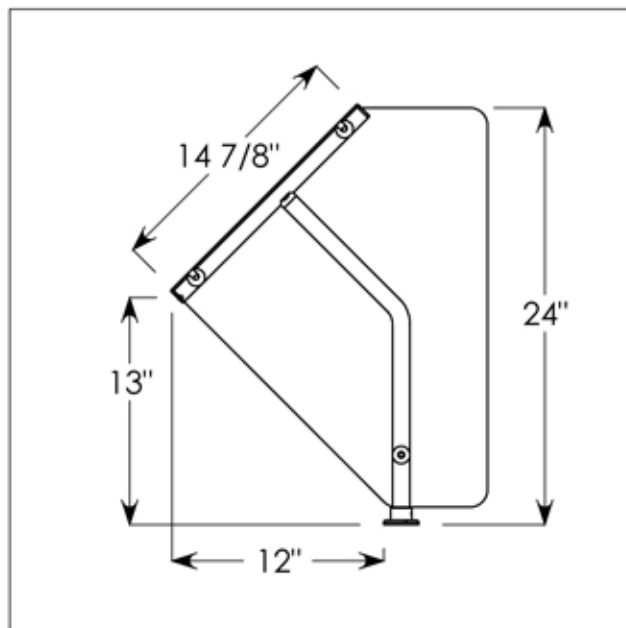
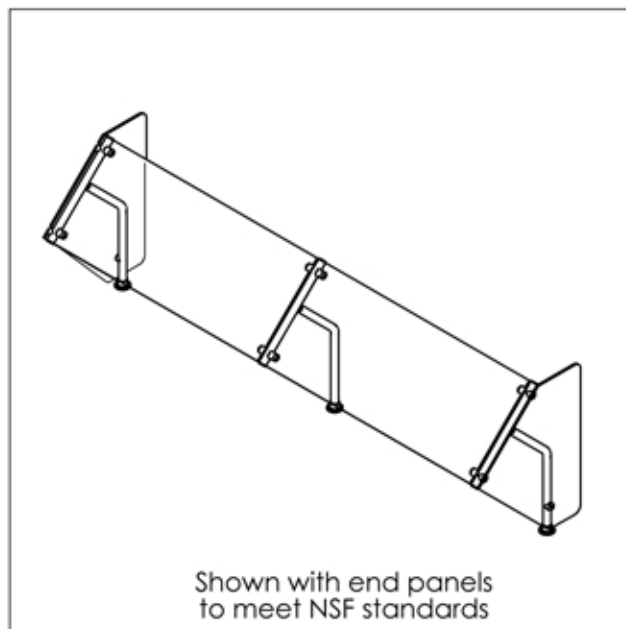

U.S. Patents: US D497,739 S
 US D472,083 S
 US D575,560 S
 Additional patents pending

